

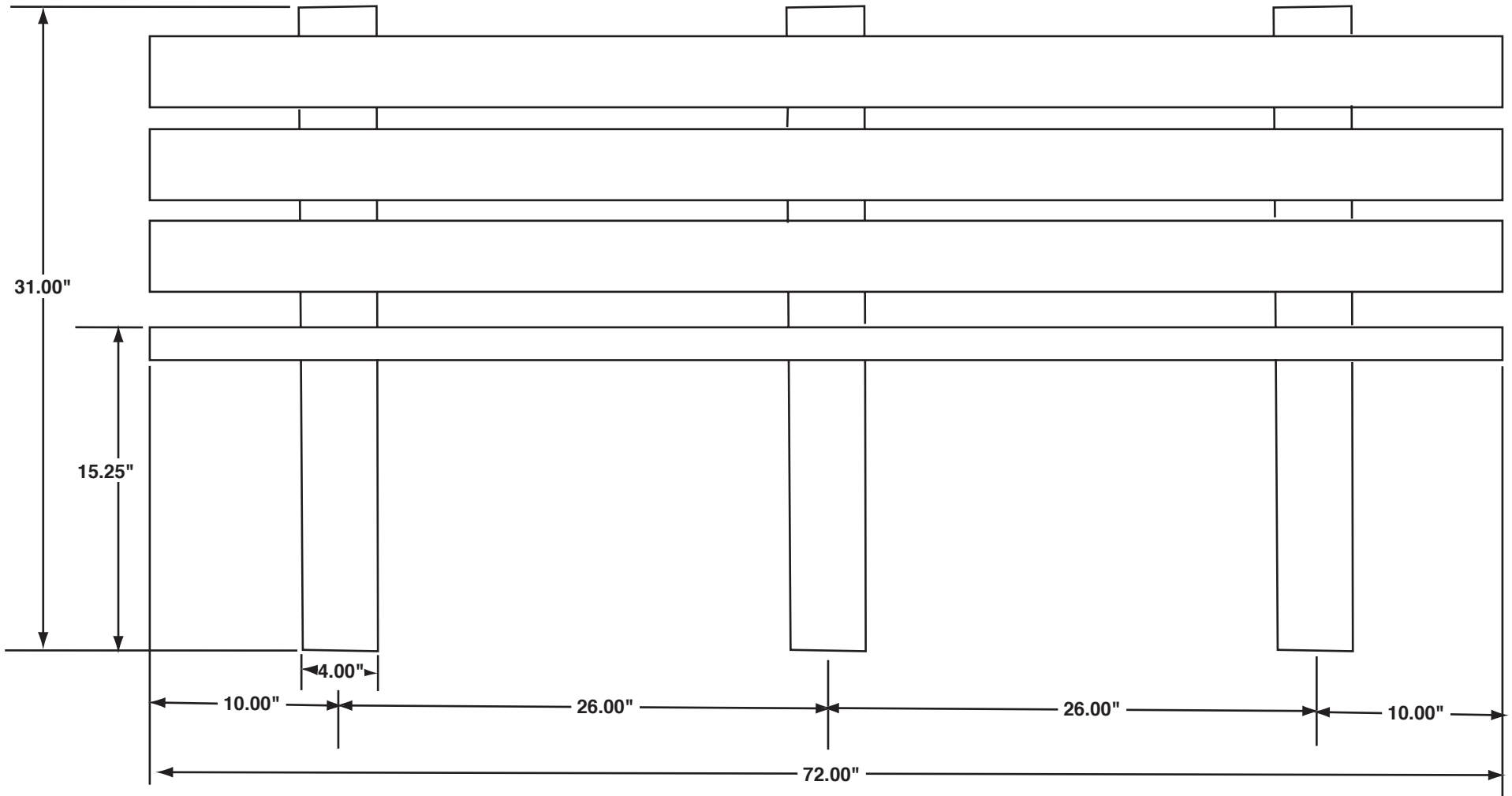

## Specifications for item 133-1010



3350 NW Boca Raton Blvd., Suite B2 Boca Raton, FL, 33431  
Phone: 561.620.7878 Fax: 561.620.8668

Leg Specifications

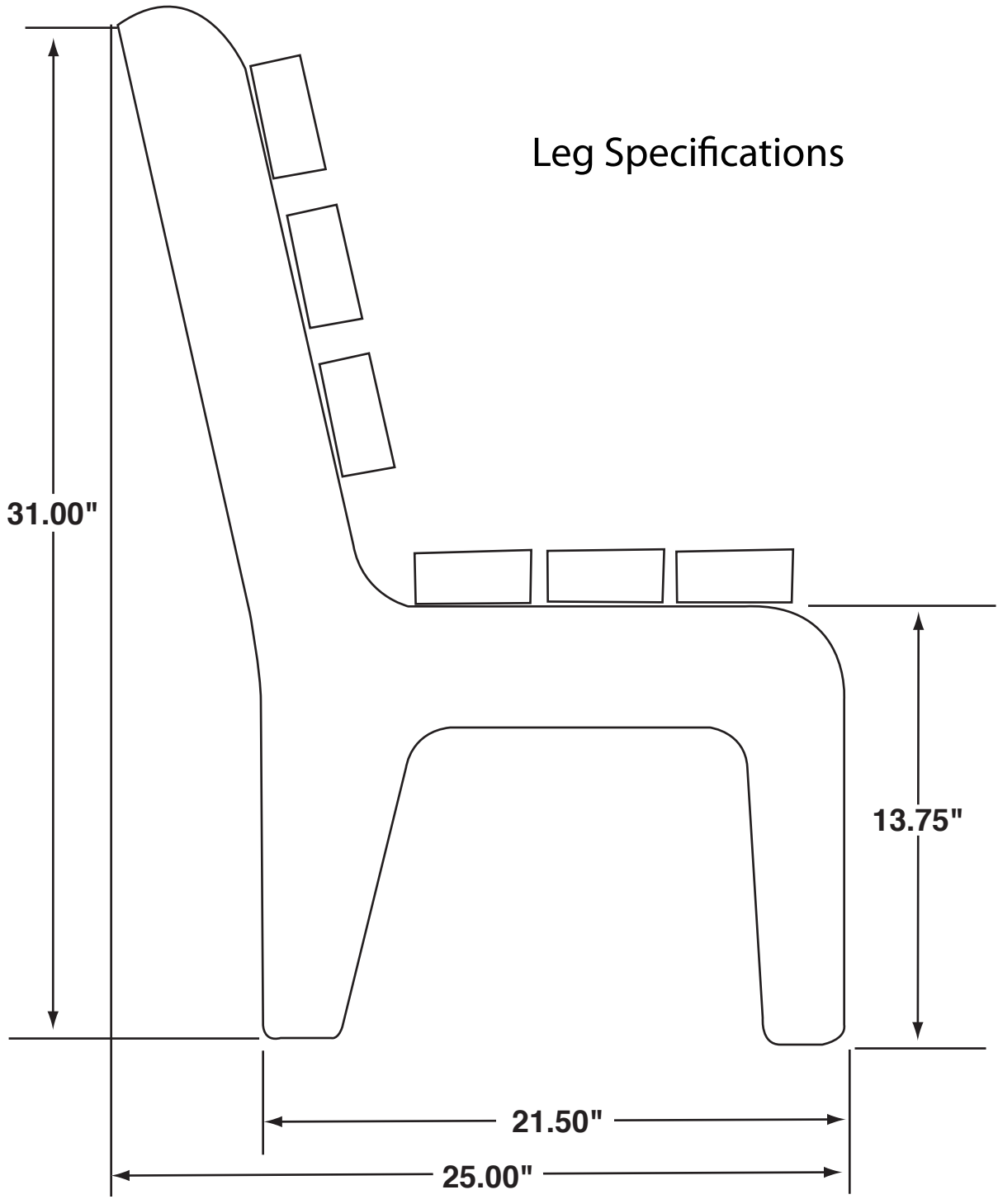

# ASSEMBLY INSTRUCTIONS

## ITEM 133-1010

**STEP 1:** PLACE THE 2 (OR 3 DEPENDING ON MODEL) “h” LEGS FACING UPRIGHT ON A LEVEL SURFACE. (ESTIMATE SPACING).

**STEP 2:** PLACE A 2” X 4” PROFILE OVER THE INSIDE SET OF HOLES ON THE SEAT OF THE “h” LEGS, MAKING SURE THE “MOLD SEAM IS FACING DOWN. SLIDE PROFILE TO ALIGN HOLES WITH THE CORRESPONDING HOLES IN THE “h” LEGS. INSERT THE 4” CARRIAGE BOLTS THROUGH EACH HOLE IN THE PROFILE AND INTO THE “h” LEGS. PLACE A WASHER AND FLANGE NUT ONTO THE BOTTOM OF EACH BOLT – **HAND TIGHTEN ONLY!!**

**STEP 3:** PLACE THE REMAINING 2” X 4” PROFILES ON THE SEAT OF THE “h” LEGS. REPEAT STEP 2.

**STEP 4:** PLACE A 2” X 4” PROFILE OVER THE INSIDE SET OF HOLES ON THE BACK OF THE “h” LEGS MAKING SURE THE “MOLD” SEAM IS FACING BACK. SLIDE PROFILE TO ALIGN HOLES WITH THE CORRESPONDING HOLES OF THE “h” LEGS. INSERT 4” CARRIAGE BOLTS THROUGH EACH HOLD IN THE PROFILE AND INTO THE “h” LEGS. PLACE A WASHER AND FLANGE NUT ONTO THE BOTTOM OF EACH BOLT – **HAND TIGHTEN ONLY!!**





**STEP 5:** PLACE REMAINING 2” X 4” PROFILES ON THE BACK OF THE “h” LEGS MAKING SURE THE “MOLD” SEAM IS FACING THE BACK. REPEAT STEP 4.

**STEP 6:** *FOR THE 4’ BENCH ONLY* – PLACE THE 2” X 18” STEEL BRACKET BEHIND THE CENTER HOLES ON THE BACK AND SEAT OF THE BENCH. PLACE 2” CARRIAGE BOLTS THROUGH PROFILES AND INTO BRACKET. PLACE A WASHER AND FLANGE NUT ONTO THE BOTTOM OF EACH BOLT – **HAND TIGHTEN ONLY!!**

**STEP 7:** ONCE ALL BOLTS, WASHERS AND NUTS ARE IN PLACE, TIGHTEN SECURELY WITH A 3/8” DRIVE RATCHET WITH A 1/2” DEEP WELL SOCKET (SHIFTING YOUR BENCH WHERE NECESSARY TO INSURE A NEAT SQUARE APPEARANCE).

**NOTE:** PROFILES MAY BE DIRECTIONAL  
AND YOU MAY NEED TO TURN THEM END-FOR-END IF THEY DO NOT LINE UP SQUARELY.

*Your 100% recycled plastic park bench will give you many years of pleasure and pride,  
knowing that you did your part in keeping plastic waste out of landfills and protecting our environment.*

	4'	6'	
REF#	QTY	QTY	DESCRIPTION
1	2	3	“h” BENCH END
2	6	6	2” X 4” PROFILE
3	1		2” X 18” BENCH BRACKET
			HARDWARE KIT
4	12	18	 5/16” X 4” CARRIAGE BOLT
5	6		 5/16” X 2” CARRIAGE BOLT
6	18	18	 5/16” WASHER
7	18	18	 5/16” FLANGE NUT

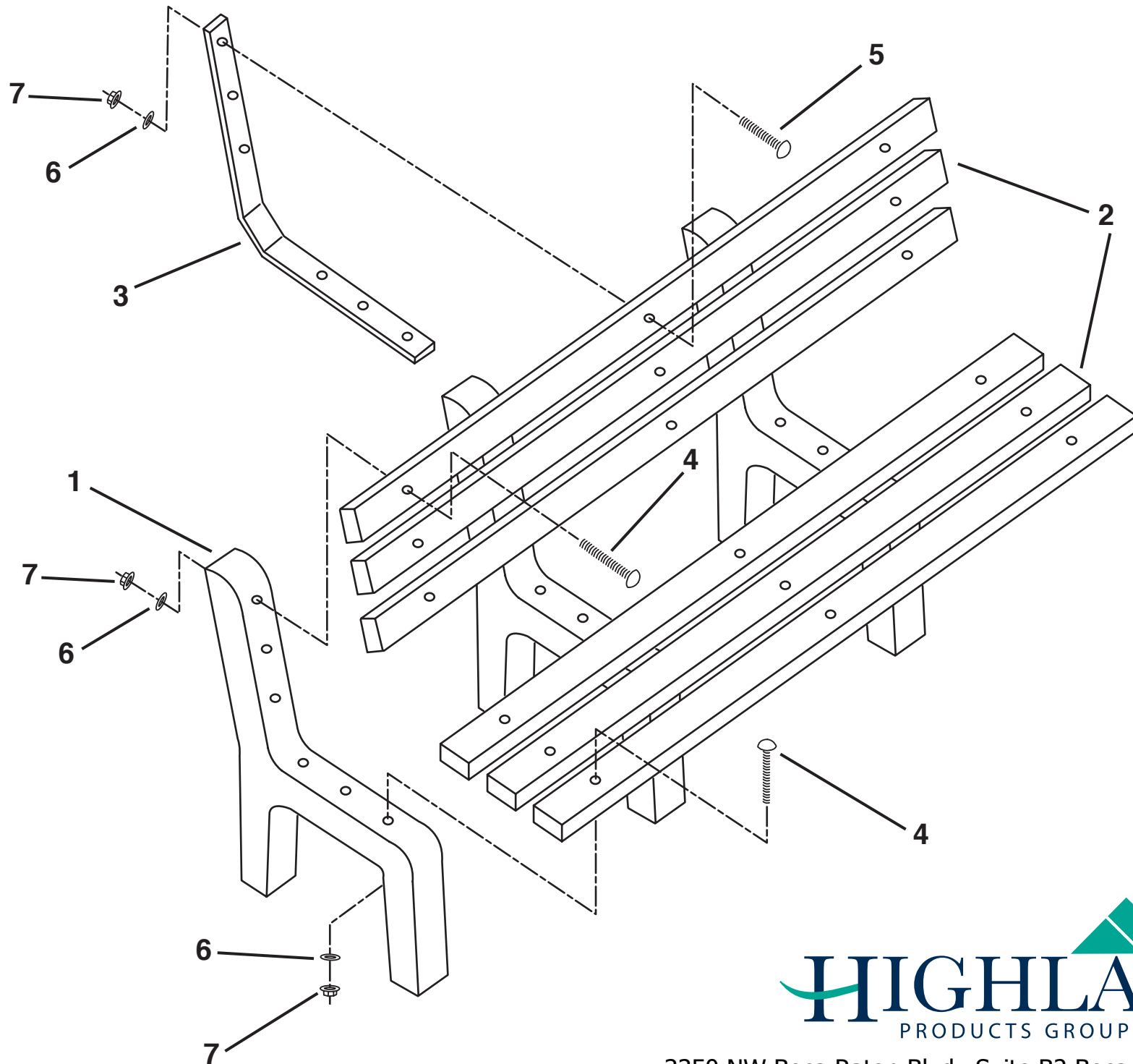

3350 NW Boca Raton Blvd., Suite B2 Boca Raton, FL, 33431  
Phone: 561.620.7878 Fax: 561.620.8668